

TECHNICAL DOCUMENTATION |

M2M GEKKO

32:128 | 64:64 | 64:128

Revision A.7

Redacted by Victor FOSSARD

Approved by Thierry COUTURIER

Date : 21/06/2019

© 2019 Eddyfi Technologies

SUMMARY

1. MECHANICAL DRAWING
2. PHASED ARRAY CONNECTOR
3. UT CONNECTORS
4. ENCODER CONNECTOR
5. I/O CONNECTOR
6. POWER CONNECTOR
7. BATTERY SLOT
8. AUTOMATIC BOOT
9. FRONT PANEL
10. ACCESSORIES
11. GLOBAL WARNING
12. BATTERY WARNING
13. CLEANING
14. TECHNICAL SPECIFICATIONS

1. MECHANICAL DRAWING

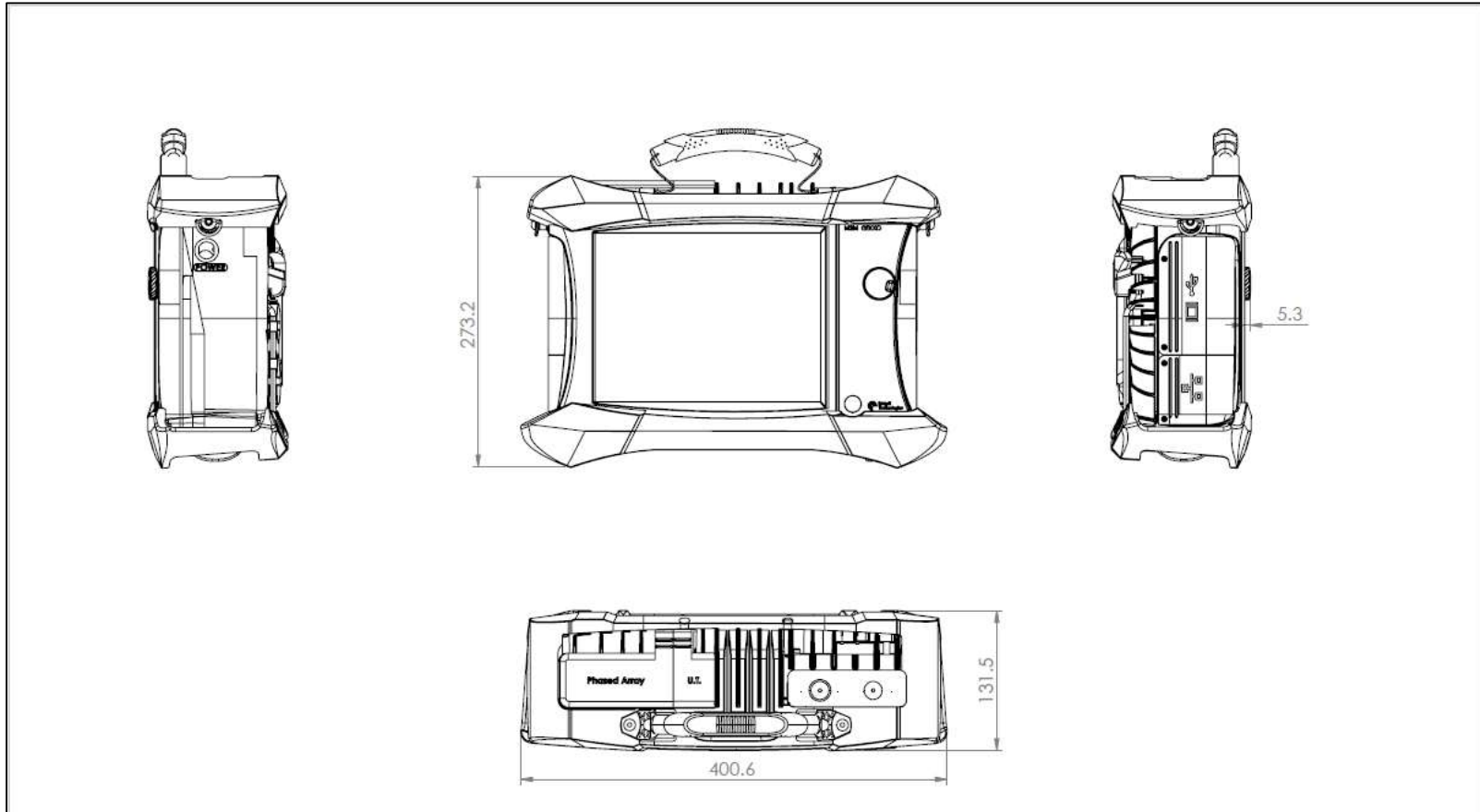

2. PHASED ARRAY CONNECTOR

Connector Location

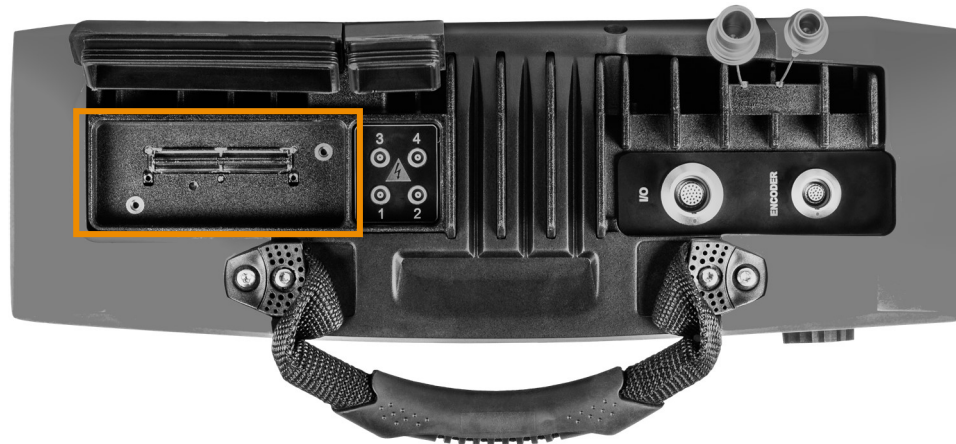

Connector Information

Supplier: I-PEX

Reference: 30046-160T-F

Connector Utility

- Plug Phased-array IPEX probes
- Connect probe splitters or probe adaptors
- Compatible with IPEX easy-latch adaptor frame:
IMP_0061-EASYLATCH-ADAPT

Matching Connector

Supplier: I-PEX

References:

- straight: 30056-160T-F
- right angle: 30047-160T-04F



For electric safety reasons, only accessories approved by Eddyfi Technologies can be used with our system. Before purchasing any probe, please contact us.

2. PHASED ARRAY CONNECTOR

Connector Mapping

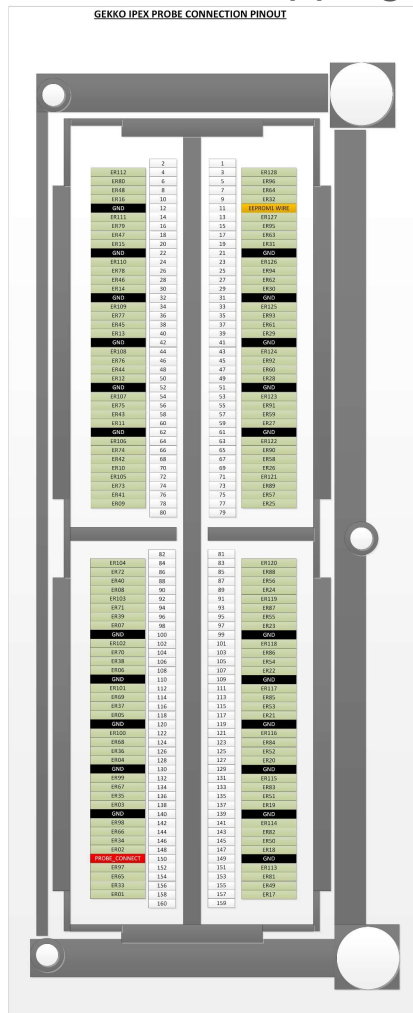

Connector Signal Description

| Signal Name | Description | User matching signal |
|--------------|---------------------------------------|---|
| ER1 to ER128 | Phased-array channel number 1 to 128* | Phased-array probe channel 1 to 128* |
| GND | Ground pin | For better ultrasound result, all GND pin have to be connected to probe ground. |

* Depend on the hardware configuration (32:128PR, 64:64PR or 64:128PR).

3. UT CONNECTORS

Connectors Location

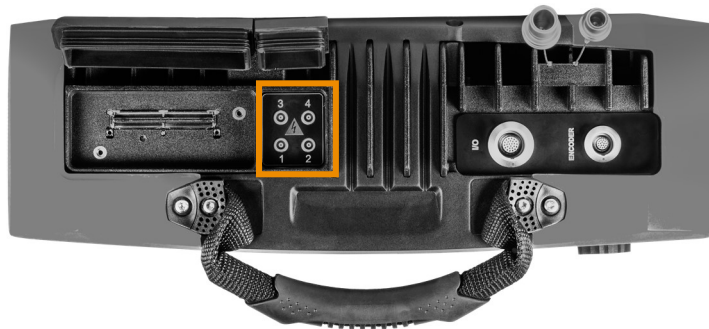

Connector Utility

4 independent P/R LEMO allowing to use :

- 4 conventional UT probe in pulse-echo mode
- 2 pairs of TOFD or 2 Dual element probes

Connector Information

Supplier: LEMO

Reference: ERN.00.250.CTL

Matching Connector

UT connector is NimCAMAC standard.

Supplier: LEMO

Reference: FGG.00.302.CLAD35

Connector Mapping

| Pin number | Pin signification |
|------------|-------------------|
| 1 | U.T |
| 2 | GND |

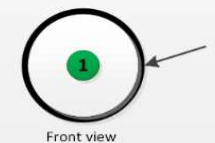

For electric safety reasons, only accessories approved by EDDYFI can be used with our system. Before purchasing any probe, please contact us.

4. ENCODER CONNECTOR

Connector Location



Connector Information

Supplier: Connector type LEMO EGG

Reference: EGG.1K.316.CLL

Matching Cable

Supplier: LEMO (Connector Male 16 Pin)

Reference: FGG.1K.316.CLAC65Z



Connector Utility

- **CONNECT UP TO 3 DIFFERENT ENCODERS:**
 - +5V TTL inputs
 - quadrature mode or clock/dir mode
 - Number of available encoders : 2 or 3 depending on software setup and option.
- **INPUTS/OUTPUTS :**
 - 2 TTL inputs

4. ENCODER CONNECTOR

Connector Mapping

| Pin number | Pin signification quadrature mode | Pin signification clk/dir mode |
|------------|-----------------------------------|--------------------------------|
| 1 | Analog In | Analog In |
| 2 | DC 5V | DC 5V |
| 3 | Synchro 1 In | Synchro 1 In |
| 4 | Synchro 2 In | Synchro 2 In |
| 5 | Not used | Not used |
| 6 | Not used | Not used |
| 7 | Not used | Not used |
| 8 | Not used | Not used |
| 9 | Encoder 1 phase A | Encoder 1 Clock |
| 10 | Encoder 1 phase B | Encoder 1 Direction |
| 11 | Encoder 2 phase A | Encoder 2 Clock |
| 12 | Encoder 2 phase B | Encoder 2 Direction |
| 13 | Not used | Not used |
| 14 | Encoder 3 phase A | Encoder 3 Clock |
| 15 | Encoder 3 phase B | Encoder 3 Direction |
| 16 | GND | GND |

Encoder input

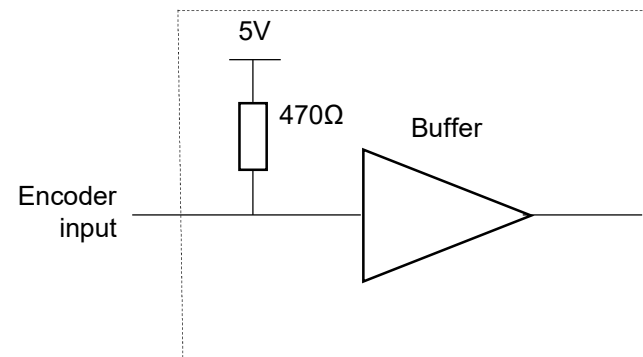

Front View of the Connector



| Signal Name | Description | User matching signal |
|-------------------|-------------|---|
| Encoder Phase A/B | TTL 5V | <ul style="list-style-type: none"> - Absolute Max current -50 mA - Max frequency = 4MHz |

4. ENCODER CONNECTOR

Connector Signal Description 3/4

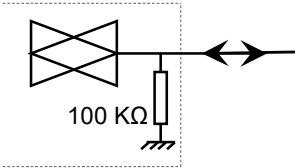
| Signal Name | Description | User matching signal |
|-------------|--|---|
| Synchro1 | <p>Synchro1 Input/Output</p> <p>TTL 5V</p>  | <ul style="list-style-type: none"> - If configured as <u>OUTPUT</u> (see in Capture software as below, Type ≠ "1-axis encoder +increment") <ul style="list-style-type: none"> - TTL 5V - = PRF = 5V/100ns pulse generated with each Pulser signal (IPEX connector). - Signal can be used to synchronize an external system - Jitter = 10ns. - Absolute Max output current +/-50 mA - If configured as <u>INPUT</u> (see in Capture software as below, Type = "1-axis encoder +increment") <ul style="list-style-type: none"> - TTL 5V, active on High level - Max Input current 50µA - When connected to Phased Array Wheel probe, Synchro1 is used as « Index Increment » (short press) and « Scan Encoder Reset » (long press > 2sec). |

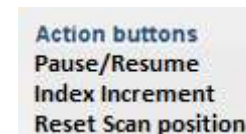
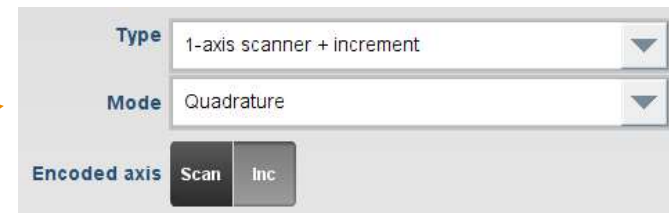
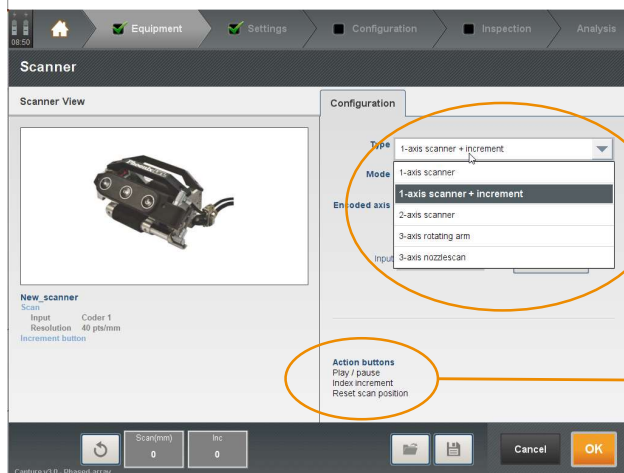

4. ENCODER CONNECTOR

Connector Signal Description 4/4

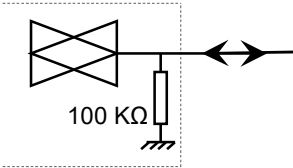
| Signal Name | Description | User matching signal |
|-------------|--|---|
| Synchro2 | <p>Synchro2 Input/Output</p> <p>TTL 5V</p>  | <ul style="list-style-type: none"> - If configured as <u>OUTPUT</u> (see in Capture software as below, Type ≠ "1-axis encoder +increment") <ul style="list-style-type: none"> - TTL 5V - = PRF = 5V/100ns pulse generated with each Pulser signal (IPEX connector). - Signal can be used to synchronize an external system - Jitter = 10ns. - Absolute Max output current +/-50 mA - If configured as <u>INPUT</u> (see in Capture software as below, Type = "1-axis encoder +increment") <ul style="list-style-type: none"> - TTL 5V, active on High level - Max Input current 50µA - When connected to Phased Array Wheel probe, Synchro2 is used as « Pause/Resume » to toggle Pause/Resume. |

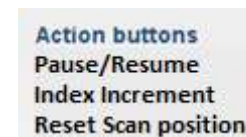
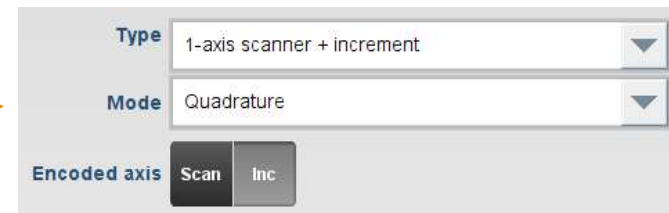
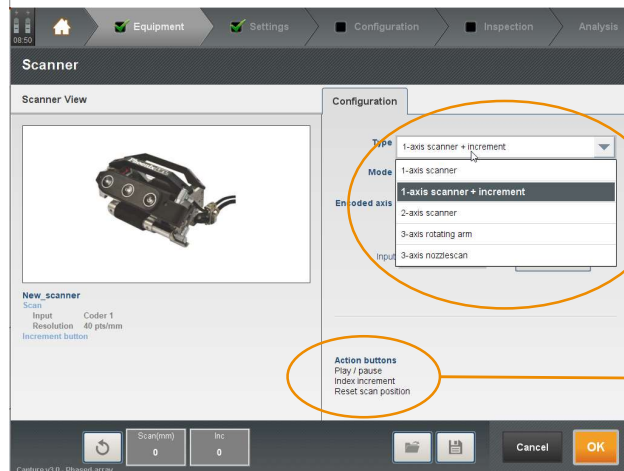

5. I/O CONNECTORS

Connector Location



Connector Information

Supplier: Connector type LEMO EGG

Reference: EGG.2K.326.CLL

Connector Utility

Outputs currently not driven by the software.

Development in progress.

Matching Cable

Supplier: LEMO (Connector Male 26 Pin)

Reference: FGG.2K.326.CLAC65

5. I/O CONNECTORS

Connector Location

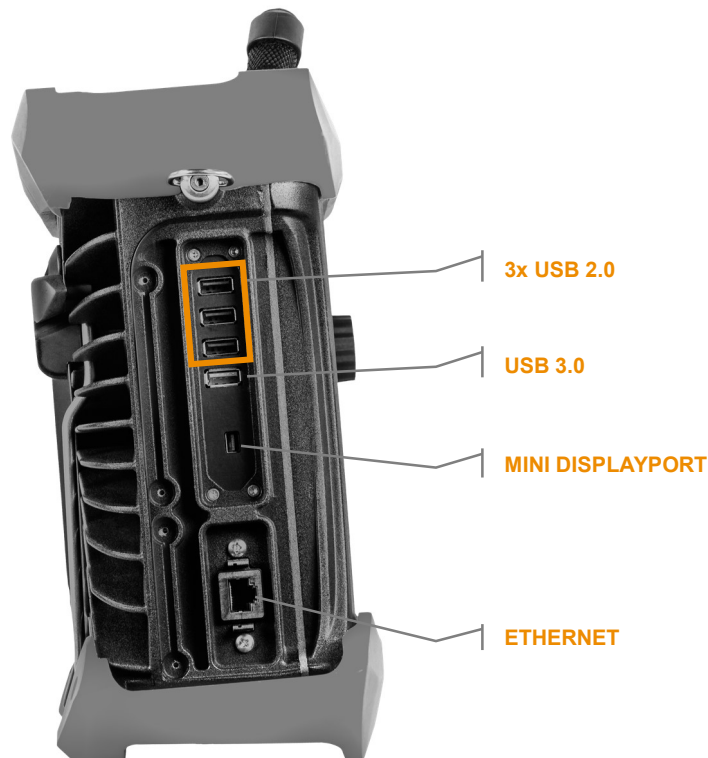

Connector description

USB

- 1x USB3.0: high-speed USB, up to 625 MB/s data transfer (depending on the USB3.0 flash drive capabilities)
- 3x USB2.0: up to 30MB/s data transfer
- USB 5VDC protected at 0.5A, by resettable fuse (system reboot required).

MICRO DISPLAY PORT OUTPUT

- 1x micro display port for video output

The external screen will be automatically detected by the GEKKO system and will keep same screen resolution as GEKKO (1024x768).

ETHERNET

- When plugged to a network, the GEKKO appears with the name GEKKO-XXXX and the « Capture files» folder is shared with anybody:
Refer to EDDYFI procedure:
 - PRO_GEKKO_INS_022-SHARING-USER-GUIDE
 - PRO_GEKKO_INS_027_GEKKO_V2_Connectivity_US-A
- The ethernet controller is 1Gb/s speed.

**When the I/O hatch is closed, the I/O connector area is waterproof.*

6. POWER CONNECTOR

Connector Location



Connector Utility

- This connector is the global system power supply.
- When plugged, the external power supply is used to :
 - Power the system
 - Charge batteries if they are not completely charged
- Even if the system is off, the battery will be charged by the external power supply.
- Only use the external power supply supplied by EDDYFI with the GEKKO.
- When plugging the external power supply, and if there are no batteries, GEKKO automatically boots up.

Connector Information

Supplier: FISCHER

Reference: DEU 104-A037-130

Matching Cable



Do not use another external power supply

Supplier: EDDYFI

Reference: CAB_0048-POWER-GEKKO

6. POWER CONNECTOR

Connector Mapping

GEKKO_CONN.POWER

| Pin number | Pin signification |
|------------|-------------------|
| 1 | GND |
| 2 | GND |
| 3 | +15V DC |
| 4 | +15V DC |

Constructor : FISCHER
Reference : DEU 104-A037-130
(115098 ZGG0.958)
Front view :

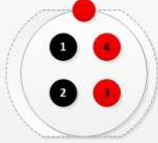

When the power cable is plugged, the position of the system should allow to easily unlock the connector. This is in order to shut down the unit in case of emergency.

7. BATTERY SLOT

2-battery slot

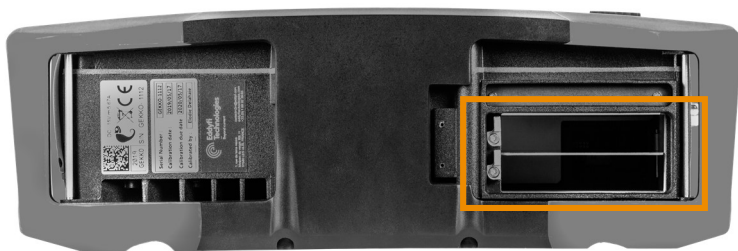

Battery Charge-discharge

WHEN PLUGGED, THE WALL ADAPTOR :

- Provide power for batteries charge (system power off) :
 - If only one battery is plugged, it is charged in 3 hours (if completely low).
 - If two batteries with a different charge level are plugged, the internal charger charges the lower battery at first. When the two batteries have the same charge level, they are charged at the same time. It takes 6 hours to completely charge 2 flat batteries.

Battery Information



Do not use another external power supply
Do not use another battery

Supplier: EDDYFI

Reference: ADD-BATT-NI2020

Battery Charger Information

2 possibilities to load batteries :

- Use the GEKKO built in recharge system.
- Use an external dual charger :

Supplier: EDDYFI

Reference: CHARG-2BATT-CH5050A

WITHOUT WALL ADAPTOR, BATTERIES POWER THE GEKKO :

- Gekko can work with one battery only.
- If batteries have different charge levels, the Gekko drains more power from the most charged battery until the levels are equal. Then GEKKO drains power equally from the 2 batteries.

IF YOU CHOOSE TO USE AN EXTERNAL CHARGER, THE CHARGE TIME IS SHORTER : 4 hours for two batteries instead of 6 hours if you use built in charger system.

To AVOID AUTOMATIC BOOT of the GEKKO while inserting the batteries (without plugging any external power supply), or while plugging the external power supply (without any batteries inserted), press **Battery Status Button**

8. AUTOMATIC BOOT

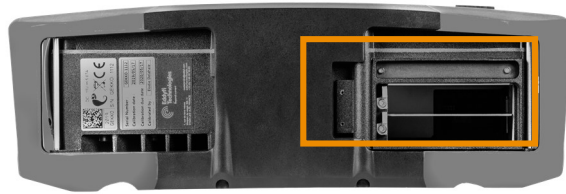

BATTERY STATUS BUTTON

Without any batteries

WHEN no batteries are in the GEKKO:

- Plugging the external power supply or supplying the external power supply with 110/240 VAC automatically boots the unit
- This feature can be used to AUTOMATICALLY and REMOTELY boot the unit up.

Without external power supply

WHEN external power is off or unplugged:

- Inserting a battery in the system automatically boots the unit

To **AVOID AUTOMATIC BOOT** of the GEKKO while inserting the batteries (without plugging any external power supply), or while plugging the external power supply (without any batteries inserted).

Press Battery Status Button

9. FRONT PANEL

Front Panel View



**BATTERY
STATUS**

ON/OFF

Meaning

BATTERY STATUS

- Push the « BATTERY » button to check the battery level :
 - GREEN for 5 seconds - Charged above 30%
 - ORANGE for 5 seconds - Charged between 10 to 30%
 - RED for 5 seconds - Charged below 10%
 - BLINKING - Charging

You can check the battery level even if the system is off.

ON/OFF

Push this button to power ON the system.

Press on ON/OFF button briefly to shut down properly the GEKKO.

Only in case the system is frozen, you can push the ON/OFF button for 4 seconds to force the power down.

To AVOID AUTOMATIC BOOT of the GEKKO while inserting the batteries (without plugging any external power supply), or while plugging the external power supply (without any batteries inserted), press **Battery Status Button**

9. FRONT PANEL

Front Panel View



**CLICKABLE
SCROLL WHEEL**

Meaning



CLICKABLE SCROLL WHEEL

- TURN the wheel to adjust values, cursors, ...
- PRESS the wheel to validate the new value, position, ...

OTHERS

For other buttons see software user guide.



10. ACCESSORIES

| Accessory Name | Description | Picture |
|---|---|---|
| Easy-Latch EDDYFI ref : IMP_0061-EASYLATCH-ADAPT | This accessory allows the connection of a probe with an EASY_LATCH connector to GEKKO system. |  |
| Dongle Wi-Fi EDIMAX ref: EW-7811Un | This accessory allows the WiFi connection to the GEKKO system. |  |

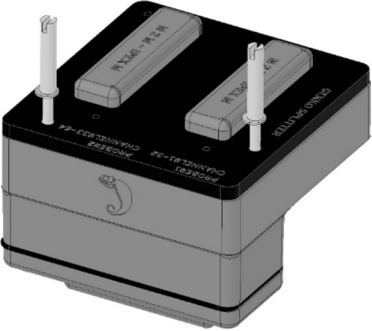

10. ACCESSORIES_PROBE

| Accessory Name | Description | Picture |
|--|---|--|
| IPEX -> FRB Adaptor EDDYFI ref: ADAPT-FRB-IPEX GEKKO | This adaptor allows connection of a probe with an HYPERTRONICS (FRB) connector to the GEKKO system. |  |
| Available splitter models : SPLITTER 1x64 -> 2x32 SPLITTER 1x128 -> 4x32 SPLITTER 1x128 -> 2x64 SPLITTER 1x64 -> 2x30 + 4 LEMO SPLITTER 1x128 -> 2x62 + 4 LEMO EDDYFI ref : CAB_0109-SPL-FRB128-4X32 | The GEKKO channels are splitted to two different I-PEX connectors and LEMO-00 connectors (optional) |  |

10. ACCESSORIES_BATTERIES

| Accessory Name | Description | Picture |
|--|---|---|
| BATTERY EDDYFI ref : ADD-BATT-NI2020 | Additional battery. 10.8V – Lithium Ion 8.7Ah / 94Wh |  |
| BATTERY CHARGER EDDYFI ref : CHARG-2BATT-CH5050A | External dual battery charger able to charge 2 GEKKO batteries in 4hours. |  |

10. ACCESSORIES_CABLES

| Accessory Name | Description | Picture |
|--|---|--|
| Adaptor for MicroD25 system EDDYFI ref : CAB_0069D | This cable allows to connect MicroD25 encoder type to GEKKO system. |  A black cable with a MicroD25 connector on one end and a GEKKO connector on the other. |
| Adaptor for SUBD15 system EDDYFI ref : CAB_0104A | This cable allows to connect SUBD15 encoder type to GEKKO system. |  A black cable with a SUBD15 connector on one end and a GEKKO connector on the other. |



11. GLOBAL WARNINGS

Do not use the device for purposes other than those for which it was designed.

Do not inspect parts of the human body or animal body with GEKKO systems.

The use of non-compatible devices can cause device failure.

To avoid personal injury or property damage, do not disassemble, modify or attempt to repair the unit.

Carefully read the instructions in the user's manual before turning the unit on.

Obey all safety warnings on the unit and those contained in the User Manual.

Do not install substitute parts or do not make modifications not allowed on the device.

Repair instructions, if any, are for qualified technical staff. To prevent from dangerous electric shock, do not perform any repair unless qualified to do it. For any problems or questions about this product, please contact EDDYFI TECHNOLOGIES or an authorized representative of EDDYFI TECHNOLOGIES.

The deterioration of the GEKKO screen is not covered by the guarantee.

Before turning on power, connect the ground of the device to the protective conductor of the power cord (sector). The plug must be inserted only into a mains socket outlet with ground contact. You should never cancel function protection using an extension cord (power cable) without a protective conductor (grounding).

When the protective grounding seems damaged, you must power down the unit and prevent unintentional operation.

The device must only be connected to a power source of the type described in the Technical document.

Prior to trash GEKKO system, make sure to comply with local laws.

In accordance with European Directive 2002/96 / EC on waste electrical and electronic equipment (WEEE), this symbol  indicates that the product should not be disposed with municipal waste but must be part of a separate collection. Please consult your EDDYFI TECHNOLOGIES local representative for instructions on returning the unit or find feasible collection arrangements in your country.

To have unconnected connectors IP certified, it is important to install rubber protectors of the unit before proceeding with cleaning the housing. Otherwise, liquid may get into the slots or flow into the housing and damage electronics boards.

The probes connected to the GEKKO must be equipped with reinforced insulation.



11. GLOBAL WARNINGS

To avoid injury, be careful not to place your fingers between the support leg and body of the system and in any connector of the system.

Avoid touching the inner conductor of I-PEX and LEMO connectors to reduce the risk of electric shock. The tension of the inner conductor of UT connectors can reach 315 V and the voltage of the inner conductor PA connector can reach 135 V.

Do not insert your finger inside two sink fins on the back of the system.

Do not insert your finger between back rubber part and axis needed for carrying strap.

The GEKKO system have V.E.S.A compatible fixation on the back. Please contact EDDYFI before using these fixation plot.

Do not insert your finger in the two batteries slot.

It is forbidden to handle the system by the top rubber part.

The system has not been designed to be installed in vertical position. Please always use the back-support leg to ensure stability of the system.

To completely disable the system, unplug the AC adaptor.



12. BATTERY WARNINGS

Do not attempt to open, crush or puncture the battery; this may cause injury.

Do not incinerate. Keep the battery away from fire and other sources of extreme heat. Exposure of battery to extreme heat sources (over 80 °C) may cause explosion.

Do not drop the battery, do not hit and do not subject it to other abuse as it could expose the corrosive and explosive content of the cells.

Do not short-circuit the terminals of the battery. A short circuit can cause severe damage to the battery and make it unusable.

Do not expose the battery to moisture or rain; this may cause an electric shock.

Charge the batteries only through the GEKKO or external charger approved by EDDYFI NDT.

Do not store the battery if the battery level is below 30%. Recharge the battery charge level between 30% and 70% before storing.

Remove the batteries from GEKKO when storing the device during a long time.

The transport of Li-ion batteries is governed by the Recommendations on the transportation of dangerous goods in United States. Governments, intergovernmental organizations and other international organizations must follow the provisions contained in these recommendations to promote global harmonization in this area. Among these organizations include the International Civil Aviation Organization (ICAO) the International Air Transport Association (IATA), the Maritime Organization international (IMO), the Department of the US Transportation (USDOT), and others. Please contact the carrier to check what are the regulations before shipping Li-ion batteries.



13. CLEANING

External surfaces of GEKKO, that is to say the housing, protector of the LCD screen can be cleaned when necessary. Make sure the unit is closed, power cord disconnected, and batteries removed.

Disconnect all cables and connectors and check that the rubber protectors are closed on all external GEKKO ports. Make sure that the battery compartment cover is securely closed. To restore the original appearance of the unit, clean the housing with a soft cloth. To remove stubborn stains, use a damp cloth with a mild soap solution. Do not use abrasives or strong solvents which could damage the finish. Once you have removed the connector protection, make sure they are dry before connecting anything else. If the connectors are wet, dry them with a soft dry cloth or let them air dry.

Never use abrasives or strong solvents to clean the GEKKO screen. Clean with a damp cloth and washer fluid. If you have no washer fluid, use a standard glass cleaner. If appropriate, use a soft brush to remove paper towel waste.

14. TECHNICAL SPECIFICATIONS

| INSTRUMENT | |
|--------------|--|
| Size | 400,5 mm x 273mm x 131,5mm |
| Weight (g) | 6,4 Kg with 1 battery 14.1 lbs |
| Power supply | DC - 15V / 5,67A / 85 VA AC - 100V-240V / 105VA |
| Battery | 2 Li-Ion batteries, 94 Wh Up to 6h with 2 batteries (hot swap capabilities) |
| Display | Size 26cm (10,4') Brightness 800 cd/m ² Resolution 1024x768 Contrast 900:1 Resistive touch screen |
| Storage | 256 GB SSD, expandable up to 1TB |

| ENVIRONMENT | |
|-----------------------|---|
| IP rating | Designed for IP66 |
| Operating temperature | -10 to 45°C (14 to 113°F) |
| Storage temperature | w/ batteries -20 to 60°C (-4 to 140°F) w/o batteries -20 to 70°C (-4 to 158°F) |
| Drop-tested | According to MIL-STD-810G |

| CONNECTIVITY | |
|-----------------------|---|
| Phased-Array | IPEX (x1) |
| UT-TOFD | LEMO-00 (x4) x4 P/R or x2 P/C |
| Encoder Input* | LEMO16 connector Up to 3 TTL Quadrature or clock/dir 4MHz max |
| Synchro Input Output* | 2 TTL inputs |
| USB | USB 3.0 (x1) USB 2.0 (x3) |
| Display | Micro display port (x1) |

| AVAILABLE CONFIGURATIONS | |
|--------------------------|--|
| Without TFM | 32:128PR 64:64PR 64:128PR |
| With TFM | 32:128PR-TFM32 32:128PR-TFM64 64:64PR-TFM64 64:128PR-TFM64 64:128PR-TFM128 |

* Depends on the hardware configuration (32:128PR, 64:64PR or 64:128PR).

14. TECHNICAL SPECIFICATIONS

| Phased-Array | |
|-------------------------------|---|
| Pulser | |
| Number of channels | Up to 128* |
| Pulse type | Bipolar square pulse |
| Amplitude | From 12 to 120 V (1V) – No load (in Capture software) From 10 to 100 V (1V) – Load 50 ohms |
| Pulse width | Pulse width from 30 to 1250 ns False time < 6ns |
| Receiver | |
| Number of channels | Up to 128* Up to 64* active channels, simultaneously |
| Input impedance | 50Ω |
| Frequency range | Frequency range 0.4 to 20 MHz |
| Max. input signal | 2 Vpp |
| Gain | 0 to 120 dB - 0.1dB step |
| Active aperture | Up to 64* elements |
| Compliant with EN ISO 18563-1 | |

| FMC/TFM | |
|-----------------------|--|
| TFM | Real-time, up to 128 elements 256 Kpi |
| Refresh rate | Up to 110 Hz at 65 Kpi |
| ATFM (Adaptative TFM) | Real-time |
| FMC | Recording capability |
| Modes | Direct, indirect and converted modes |
| Image resolution | Above 4 Mpi in post-processing |

* Depends on the hardware configuration (32:128PR, 64:64PR or 64:128PR).

14. TECHNICAL SPECIFICATIONS

| Conventional UT | |
|-------------------------------|--|
| Pulser | |
| Number of channels | 4 – up to 4 P/R or 2 P/C |
| Pulse type | Negative square pulse |
| Amplitude | From 12 to 200 V (1V) |
| Pulse width | Pulse width from 30 to 1250 ns False time < 5ns |
| Receiver | |
| Number of channels | 4 – up to 4 P/R or 2 P/C |
| Input impedance | 50Ω |
| Frequency range | Frequency range 0.6 to 25 MHz |
| Max. input signal | 1.4 Vpp |
| Gain | 0 to 120 dB - 0.1dB step |
| Compliant with EN ISO 12668-1 | |

| Digitizer | |
|----------------------|-------------------------|
| Amplitude resolution | 16 bits |
| Real-time averaging | 1 to 32 |
| FMC A-scan range | 8K max |
| Sampling frequency | Up to 100MHz |
| Signal processing | Rectified, RF, Envelope |
| A-scan size | Up to 65K samples |

| Acquisition | |
|--------------------------------|-------------------------|
| PRF | Up to 40 KHz |
| Data throughput on SSD | Up to 180 MB/sec |
| A-scan and Peak recording | |
| Data file size | Limited by SSD capacity |
| Data compression | Up to 32 |
| “Live data missed” information | |

* Depends on the hardware configuration (32:128PR, 64:64PR or 64:128PR).

Contact us

Any questions :

Support-m2m@eddyfi.com

Hardware problems with your unit :

MaintenanceEddyfiEurope@eddyfi.com

